



USER MANUAL



"The Tungsten Electrode Experts"

since 1992

2651 Lavery Court • Newbury Park, CA 91320

Tel: 805.498.3837 • Fax: 805.498.9347

sales@diamondground.com

www.diamondground.com



PIRANHA II TUNGSTEN GRINDER

USER MANUAL

TABLE OF CONTENTS

1.	INTRODUCTION	3
2.	SPECIFICATIONS	4
3.	WARRANTY	4
4.	SAFETY	4
5.	UNPACKING AND MOUNTING	5
6.	PREPARING ELECTRODES	5
7.	WHEEL REPLACEMENT	8
8.	EXPLODED ASSEMBLY DRAWING	9
9.	PIRANHA II PARTS LIST	10
10.	TUNGSTEN OPTIONS AND ALTERNATIVES	11
11.	OPTIONAL COLLET KIT W/PART LIST	12

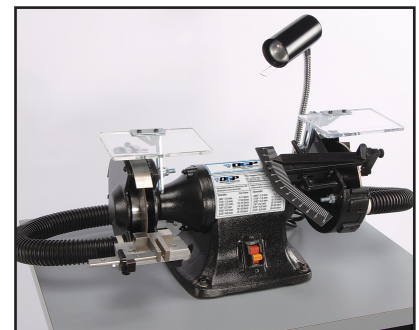

1. INTRODUCTION

Thank you and congratulations on your purchase of the Piranha II™ Tungsten Grinder, manufactured by Diamond Ground Products in Newbury Park, CA, U.S.A. We appreciate your choice of this quality product and expect that it will provide you with many years of reliable service. It is built to last and comes with a one-year warranty against manufacturing defects.

FEATURES:

- Easy set-up, optimal consistency and near-perfect repeatability.
- Compact, durable and solid design.
- Longitudinal 20 RA grinding for maximum arc starting, arc stability, electrode life & weld penetration.
- Universal collet arm for 3 electrode sizes - .040" (1.0mm), 1/16" (1.6mm), 3/32" (2.4mm) - with no equipment changes.
- Angle scale included for angles from 10° - 60°
- Precision tip flat gauge & depth adjustment stop ensures exact tungsten points every time - enabling consistent, repeatable arc performance and welding output.
- Containment baffle to keep dust inside the grinder housing, for safety and easy disposal.
- Tip flat block for square end grinding and removing bad tips.
- Electrode notching station for simple cut-off.
- Double-sided grinding wheel for maximum wheel life and value.
- Detailed manual for valuable engineering data and welding recommendations.

BENEFITS:

- SAFETY
- WELD QUALITY
- PRODUCTIVITY
- VALUE



2. SPECIFICATIONS

Range of Included Angle:	10° - 60°
Electrode Diameters:	.040”(1.0mm), 1/16” (1.6mm), 3/32” (2.4mm)
Minimum Electrode Length:	1.75” (44.5mm)
Voltage:	110/120 VAC, 50/60Hz, 220v
Power Consumption:	70 Watts
Motor:	1/10 hp, 8,000 rpm, 1.5 amps
Length:	7.8” (199mm)
Width:	4.0” (102mm)
Height:	61” (155mm)
Weight:	14 lbs (6.35kg)

3. WARRANTY

The Piranha II Tungsten Grinder comes with a one-year warranty on parts and labor, excluding the diamond-grinding wheel that is a consumable part that naturally wears over time. This warranty also excludes abuse to the machine, dropping of the unit or improper handling by the operator.

4. SAFETY

Before any work is done, read the caution below carefully. Working safely prevents accidents.

- When not in use, turn the grinder off for safety purposes and to decrease wear on the machine.
- Wear proper apparel. Do not wear loose clothing, gloves, neckties, rings, bracelets, or other jewelry, which may get caught, in moving parts of the machine.
- Wear protective hair covering to contain long hair.
- Wear safety glasses and a facemask.
- Be alert and think clearly. Never operate power tools when tired, intoxicated, or when taking medication that may cause drowsiness.
- Work area should have sufficient lighting.
- A proper electrical outlet should be available for the tools. A three-prong plug should be plugged directly into a three-prong outlet. Extension cord should be the correct gauge.
- Keep visitors at a safe distance from work area.
- Always unplug grinder prior to inspection.
- Read this manual thoroughly for specific adjustments and operating procedures.
- Do not perform “make-shift” repairs. Any part that is damaged should be promptly replaced.
- Only use the grinder for its intended purpose. Do not use it for a job it was not designed for.
- Make sure that the grinder is off before plugging it in.
- Do not apply extreme force on the tungsten while grinding. This may cause your grinder to jam or cause pre-mature grinding wheel wear.
- Never leave the grinder unattended. Turn the grinder off first and do not leave it until it comes to a complete stop.
- Keep hands away from moving parts.
- Know your grinder; learn its operation, applications, and specific limitations.

5. UNPACKING & MOUNTING

The first thing you should do is check for shipping damage. Diamond Ground Products, Inc. takes great pride in producing quality products. If for some reason you find anything to be defective, please contact the Service Department at (805) 498-3837 and we will work with you to rectify the problem to your satisfaction.

After unpacking the box you should have these items:

- The Piranha II Tungsten Grinder.
- Three Allen wrenches, sizes 3/32", 7/64" & 1/8" for replacing wheels.
- PII Manual
- Pin Vise

Mounting of the grinder is as follows. Place the unit on a flat surface allowing enough space for the operator to work in. This also provides proper ventilation. Make sure the power switch is in the off position and plug it into the electrical outlet. Switch the power on and the unit is ready to operate.

6. PREPARING ELECTRODES

ADJUSTING HANDLES

The set up procedure for the included angle may require the use of both adjustment handles, which are listed above as A and B. When handle A is loosened, it allows you to rotate the Universal Collet Arm to choose the included angle that you would like to grind your tungsten. Handle B allows you to adjust the location at which the tungsten will touch the wheel.

Tip Flat Gauge depth is set with Knob C and locked in place with Nut D.

THE SET UP PROCEDURE

With the power turned off, select the included angle you would like to grind by:

- 1) Loosening Handle A
- 2) Turning the Collet Arm on its axis until the Pointer is directed at the angle on the scale you desire.
- 3) Re-tightening Handle A.

Next, put the tungsten at the diameter you plan to use through the proper sized collet hole on the universal collet and observe the height at which the tungsten will hit the wheel. For setting up your first tungsten on a wheel, make the height as close to the top of the wheel as possible by:

- 1) Loosening Handle B.
- 2) Slide Collet Arm up to desired position.
- 3) Re-tightening Handle B.

The setup is now complete. After grinding numerous tungstens, you will wear a groove on the wheel. At this point, adjust Handle B again and move the contact point down a very small amount to a fresh spot on the wheel.

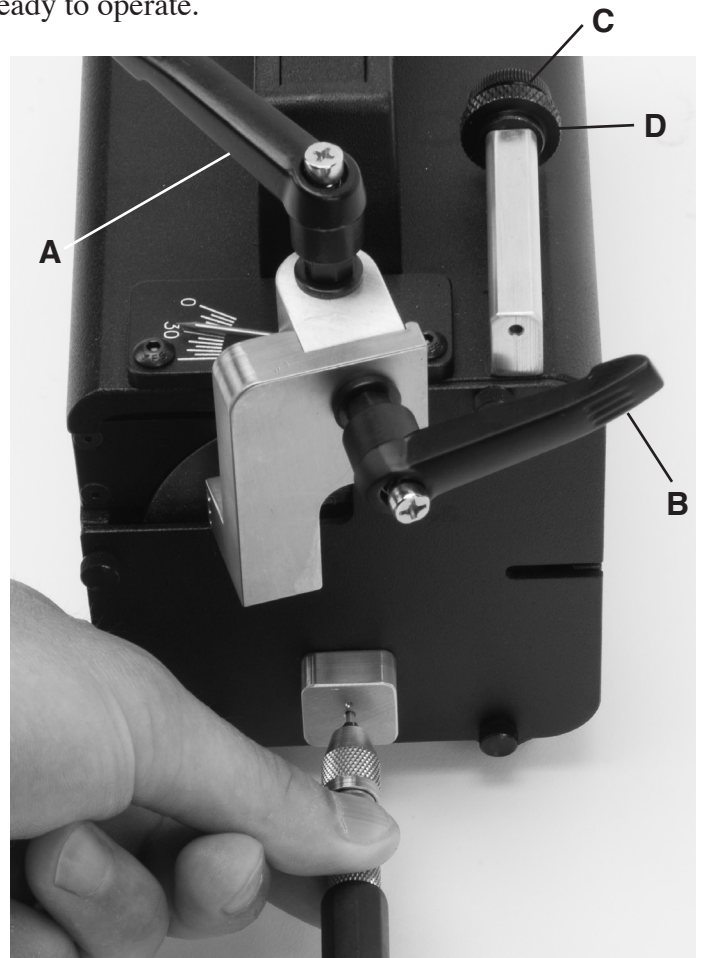

Tip Flat Gage setup:

Once the desired Pin Vise electrode stick-out is determined, set the Tip Flat Gage as follows:

Initial Gage setup:

- 1) With electrode extending to the desired length, tighten Pin Vise lock collar.
- 2) Loosen Nut D on the Tip Flat Gage.
- 3) Insert electrode into Tip Flat Gage.
- 4) Rotate Knob C until the Stop makes contact with electrode tip.
Lock the Stop in place with Nut D.

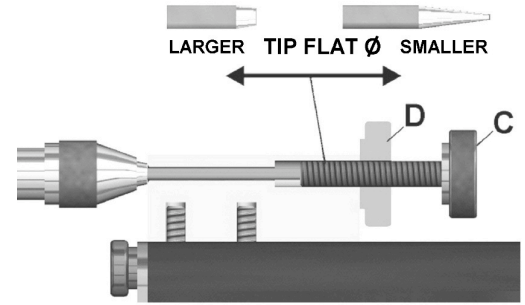

To duplicate electrode Tip Flat diameter (with Tip Flat Gage depth set per above):

- 1) Insert electrode into Pin Vise. Extension should be beyond the desired final length.
- 2) Adjust Pin Vise collar so there is a slight drag on the extended electrode.
- 3) Insert electrode into Tip Flat Gage. Slide until nose of the Pin Vise contacts the Gage face.
- 4) Secure electrode in position by tightening Pin Vise collar.

NOTE: Diamond Ground Products (DGP) Diamond Grinding wheels are specifically designed for optimum wheel life for grinding tungsten electrodes.

GRINDING TECHNIQUES

After the short set up procedure is finished you are ready to prepare your electrode quickly and easily. Turn the power switch on; slide the tungsten into the proper collet hole on the universal collet. From top to bottom the holes are: 3/32"/2.4mm, 1/16"/1.6mm, .040"/1.0mm. Lightly touch the wheel with the tungsten and rotate it in your fingers in a steady manner until you have ground to a point or left the proper sized flat you desire. Be patient and do not gouge the wheel by trying to grind the electrode too quickly. Gouging the wheel will wear a groove much faster and cause excessive wear. The approximate recommended grinding times for each of the diameters is:

3/32" / 2.4mm	15 seconds
1/16" / 1.6mm	8 seconds
.040" / 1.0mm	5 seconds

REMOVING A TIP FROM AN ELECTRODE

After welding, it is beneficial to remove a bad tip before regrinding. To do this, turn on the power and insert the tungsten in the proper sized hole from the choices you see on the Tip/Flat Block. Slowly push the tip against the wheel until the point is removed. Once again, be patient and do not gouge the wheel. A burr can form if too much pressure is exerted on the tungsten.



NOTCHING YOUR ELECTRODE

The notching feature is located at the right hand side of your unit. This feature is provided to notch your electrodes to a point where they can be split in half or to remove any existing contamination off of a spent electrode. You should never snap your electrode in half without notching it first. Snapping your electrode will cause splintering within your electrode, which will later result in contamination in your weld.

- Insert your electrode through the slot opening and push through so the electrode is exiting from opposite end. Holding both ends, push the electrode towards the corner of the rotating wheel.
- Once you have notched a sufficient amount of your electrode on one side, rotate the electrode to notch the remaining side.
- Once complete, use the Tip/Flat Block to flatten your electrode and proceed to grind as normal.

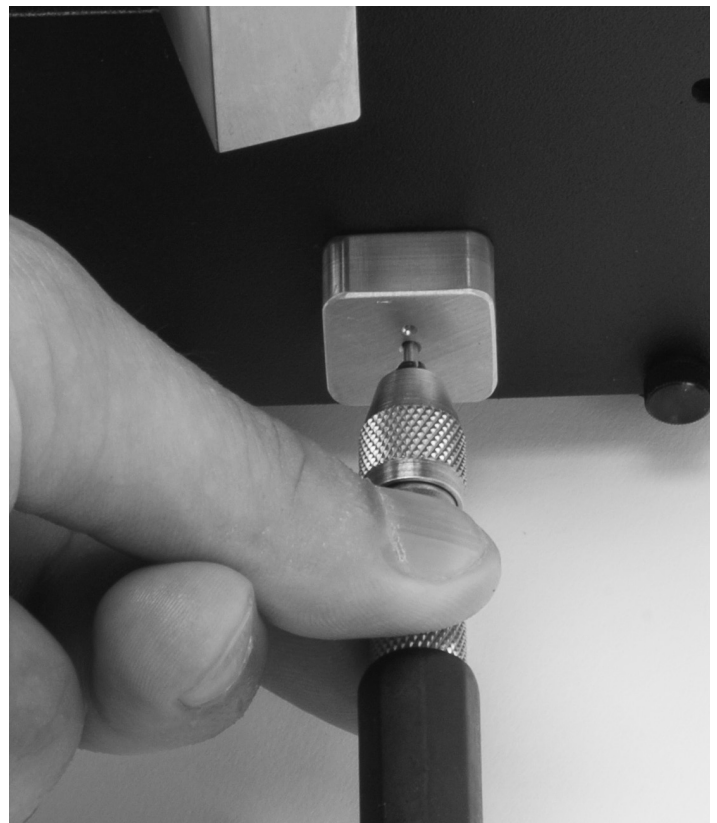
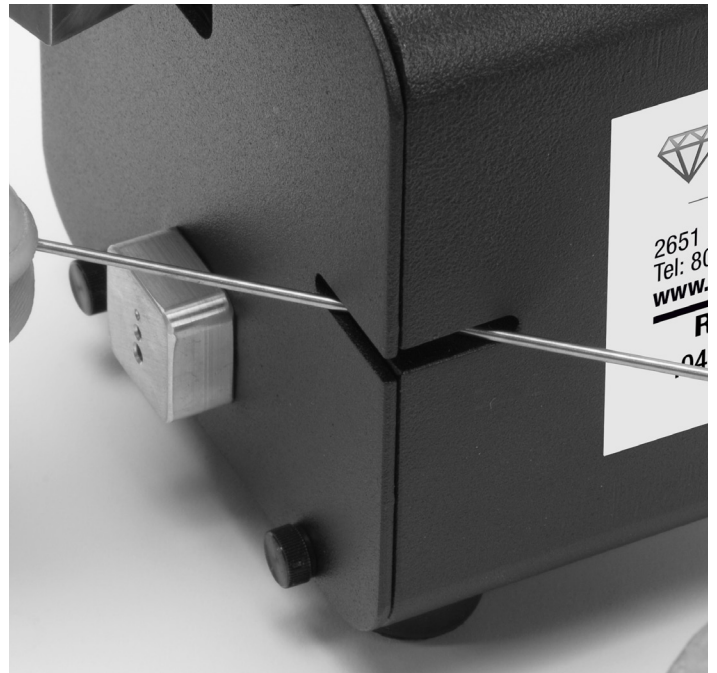

7. WHEEL REPLACEMENT

HOW TO ORDER REPLACEMENT WHEELS

The Piranha II replacement diamond wheels are available either directly through Diamond Ground Products or through local distributors who sell our products. The part number to use when ordering are listed below in the “Piranha Grinder Accessories” Chart. These wheels are in stock for immediate delivery. In manufacturing replacement wheels, a special process is used to bond the diamond to the wheel which makes these wheels last as long as possible when used for grinding tungsten. Grinding wheels other than DGP wheels will not only offer less longevity, but may be dangerous and may void the warranty on this equipment.

HOW TO INSTALL REPLACEMENT GRINDING WHEELS

Please use the following steps to remove and replace the Diamond Grinding wheels:

1. Turn the power off, unplug the electrical outlet, and wait until the motor has come to a complete stop.
2. Completely unscrew and remove Handle A (see picture at adjusting handles). Lift up and remove the Arm, taking care not to lose the washer between the Arm and the Handle. Set them aside.
3. Unscrew the four thumbscrews on the wheel cover. Remove the Wheel Cover to fully expose the Wheel.
4. Using the supplied Allen Wrench, loosen the four screws on the front of the Grinding Disk.
5. Remove the old Wheel and mount the replacement wheel on the arbor.
6. Replace all of the other parts in reverse order the exact same methods you used to remove them.

**** IMPORTANT *****

**DO NOT REMOVE OR OVER TIGHTEN ARBOR
WHEN CHANGING WHEEL, ONLY REMOVE 4 SCREWS**

- For optimum surface finish on .040 through 3/32, use a 300 Grit Diamond Wheel (699-0001) (3.15” Diameter)

PART NO. PIRANHA GRINDER ACCESSORIES

699-0004 Piranha II Grinding Wheel – 600 Grit Single Sided (3.15” diameter)

699-0003 Piranha II Grinding Wheel – 150 Grit Single Sided (3.15” diameter)

All prices are FOB Factory.

Products listed above are normally stock items- consult factory to confirm.

Net 30 terms available O.A.C for deliveries in the U.S. International orders by wire transfer.

Prices that are listed are subject to change without notice.

PIRANHHA II TUNGSTEN GRINDER

Exploded Assembly

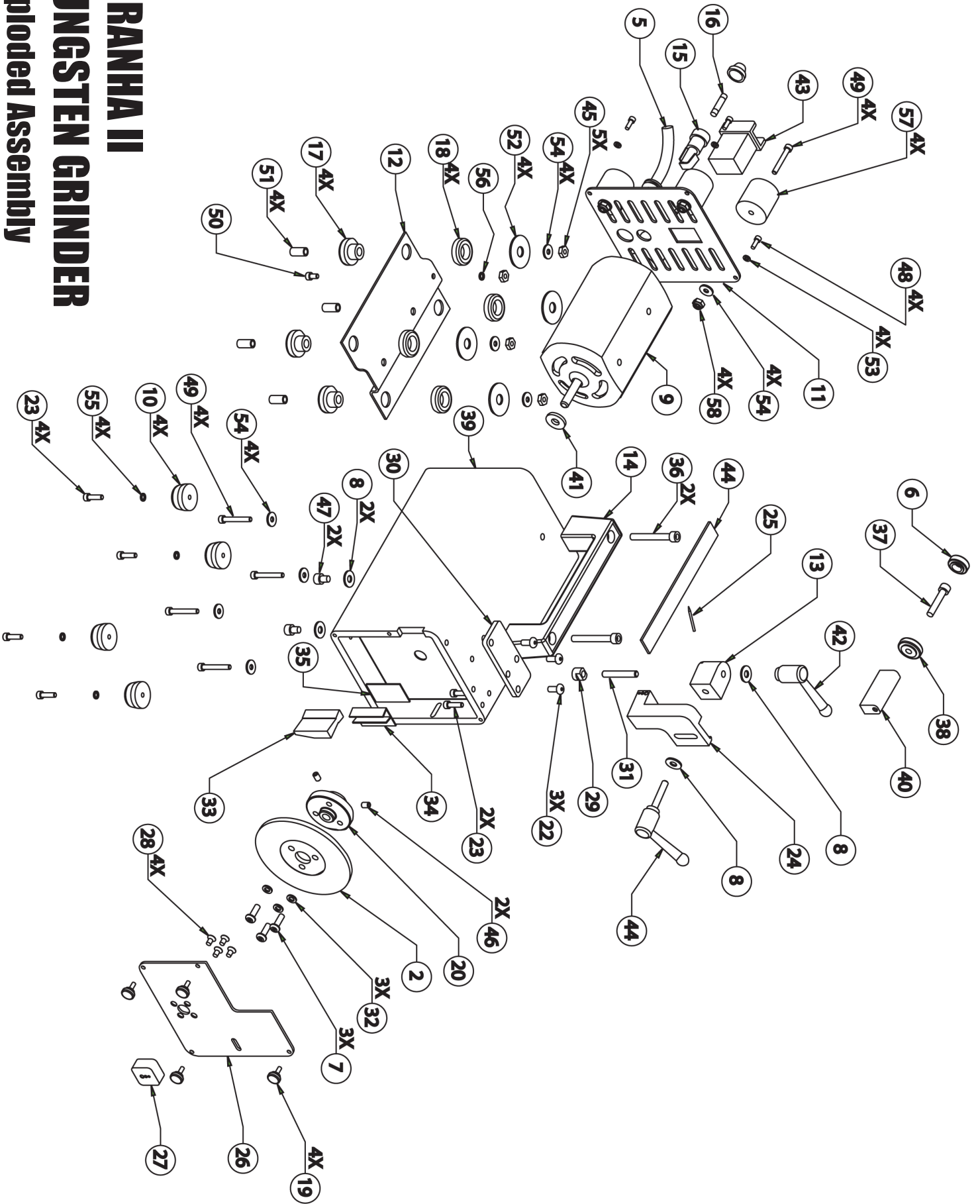

PIRANHA II TUNGSTEN GRINDER

Parts List

QTY	ITEM	PART NUMBER	NAME
-	1	DGP-PG2A	ASSY - TOP - PIRANHA II
1	2	699-0001	DISK - DIAMOND WHEEL
-	3		
-	4		
1	5	DGP-P355	POWER CORD WITH GROMMET
1	6	DGP-P460	KNOB - SHEAR-LOCK - #10 - BLACK
3	7	DGP-PG1335	BCHS - #8-32UNC X 3/8 LG
4	8	DGP-P730	WASHER - FLAT - #10
1	9	DGP-PG1080	MOTOR - AC/DC - 8K RPM
4	10	DGP-PG1130	BUMPER - FOOT
1	11	DGP-PG1301	COVER - REAR
1	12	DGP-PG1303	CHANNEL - MOTOR MOUNT
1	13	DGP-PG1305	BLOCK - PIVOT
1	14	DGP-PG1310	HANDLE
1	15	DGP-PG1312	HOLDER - FUSE 125V / 5AMP
1	16	DGP-PG1313	FUSE 125V / 5AMP
4	17	DGP-PG1315	GROMMET
4	18	DGP-PG1316	WASHER - GROMMET
4	19	DGP-PG1317	SCREW - THUMB (#4-40 X 5/16)
1	20	DGP-PG1331	ARBOR - DISK
3	22	DGP-PG1335	BHCS - #8-32 X 3/8 LG
4	23	DGP-PG1320	SHCS - #6-32 X 3/8 LG
1	24	DGP-PG1350	ARM - ELECTRODE
1	25	DGP-PG1307	POINTER - INDEX
1	26	DGP-PG1373	COVER - FRONT - 13GA CRS
1	27	DGP-PG1353	BLOCK - TIP FLAT
4	28	DGP-PG1354	SCREW-FLAT HD SOCKET-#6-32 X1/4 LG
1	29	DGP-PG1309	COLLAR - PIVOT #10-32 UNF
1	30	DGP-PG1356	PLATE - ARM MOUNT

QTY	ITEM	PART NUMBER	NAME
1	31	DGP-PG1357	STUD - #10-3 X 1-1/4 LG
1	33	DGP-PG1359	SHIELD
2	34	DGP-PG1445	SCREWS
2	36	DGP-PG1338	SHCS - #10-32 X 3/4 LG
1	37	DGP-PG1362	SHCS - #10-32 X 1.50"
1	38	DGP-PG1365	KNOB - KNURLED - #10-32
1	39	DGP-PG1370	HOUSING - WELDMENT
1	40	DGP-PG1384	BODY - STOP GAGE
1	41	DGP-PG1364	FELT WASHER SMALL F1
1	42	DGP-P410	HANDLE - ADJUSTABLE/CLAMPING 10-32
1	43	551-0001	SWITCH - ROCKER A/C
1	44	DGP-PG1000	HANDLE - ADJUSTABLE/CLAMPING 10-32
5	45	DGP-PG1325	NUT - HEX - #6-32
2	46	DGP-PG1324	SET SCREW - #10-32UNF X 1/4 LG
2	47	DGP-PG1322	SHCS - #10-32 X 1/4 LG
4	48	DGP-PG1318	SHCS - #4-40 X 5/16 LG
4	49	DGP-PG1331	SHCS - #6-32 X 1 LG
1	50	DGP-PG1337	SHCS - #6-32 X 1/4 LG
4	51	DGP-PG1314	SPACER - 1/4 OD X 1/2 LG X #6 THRU
4	52	DGP-PG1334	WASHER - 5/16 ID X 1 OD X .050 THK
12	54	DGP-PG1327	WASHER - FLAT - #6
-	55		
4	57	DGP-PG1432	BUMPER-RECESSED - 1 DIA X 1 LG
4	58	DGP-PG1323	NUT - HEX- #6-32 - NYLON INSERT
-	59		
-	60		

REF. BOM for Piranha II Top Assembly PN: DGP-PG3 Rev. C 2011

10. TUNGSTEN OPTIONS AND ALTERNATIVES

TRI-MIX™ TUNGSTEN ELECTRODE

- Three oxides scientifically balance the migration and evaporation rates to extend the service life
- Increased number of arc starts before re-sharpening and fewer misfires saves money and time
- Lower work function requires less energy to start than 2% Thoriated tungsten and runs cooler
- TRI MIX™ is a non-radioactive tungsten
- FREE Samples available upon request
- FREE Tungsten Guidebook to clarify electrode selection and preparation.

CRYO-T™ TUNGSTEN ELECTRODE

- Cryogenically treated Thoriated Tungsten produces a more dense structure of the Thoriated and tungsten blend.
- Easiest starting Tungsten.
- Much longer tip life compared to non-treated 2% Thoriated Tungsten electrodes.
- More consistent welds as a result of crisp starts and longer electrode life.

THORIATED TUNGSTEN RADIOACTIVITY INFORMATION

Thorium is a radioactive element or additive used in tungsten welding electrodes to assist in arc starting. Although companies involved in welding have been using Thoriated electrodes for many years, the industry is becoming more mindful of their potential health hazards. The following are notes, warnings, and recommendations from various organizations on the use of Thoriated tungsten welding electrodes.

American Welding Society: “Thorium is radioactive and may present hazards by external and internal exposure. If alternatives are technically feasible they should be used...” If welding is to be performed in confined spaces for prolonged periods of time or if electrode grinding dust might be ingested, special precautions relative to ventilation should be considered. The user should consult appropriate safety personnel.”

Standard Manufacture’s Warning: “Thorium dioxide is a naturally occurring radioactive element. It is an alpha emitter and, as such, its primary hazard lies in Inhalation of dust/fume.” “Thorium dioxide has been identified as a carcinogen by the NTP and IARC.” (These quotes are from Osram Sylvania MSDS sheets).

The Welding Institute: Thorium is a radioactive element. The HSE has recommended to factory inspectors that, where Thoriated tungsten electrodes are not necessary, users should be encouraged to look for alternatives.

Cancer Assessment: Thorium dioxide has been identified as a carcinogen by the National Toxicology Program and International Agency of Research on Cancer.

DIAMOND GROUND PRODUCTS OFFERS ALTERNATIVES

DGP offers Non-Radioactive High Performance TRI MIX™, 2% Lanthanated, Cryo-T and 2% Ceriated tungsten which is in stock, ready to be shipped, and affordably priced. In most welding applications, these types of tungsten outperforms Thorium with longer tungsten life, better arc starting, and, in some cases, higher amperage capacity. Call us for more information and to get a FREE sample today!

OPTIONAL SHORT COLLET KIT FOR PII

DGP-KIT-PIIs

Piranha II Short Collet Upgrade Kit

Get the performance of the new Piranha tungsten grinders without having to buy a new grinder! Our new Piranha II collet upgrade kit can be used on your older model Piranha tungsten grinder to enable you to grind tungsten as short as .750" (19.05mm). The process and directions are simple.

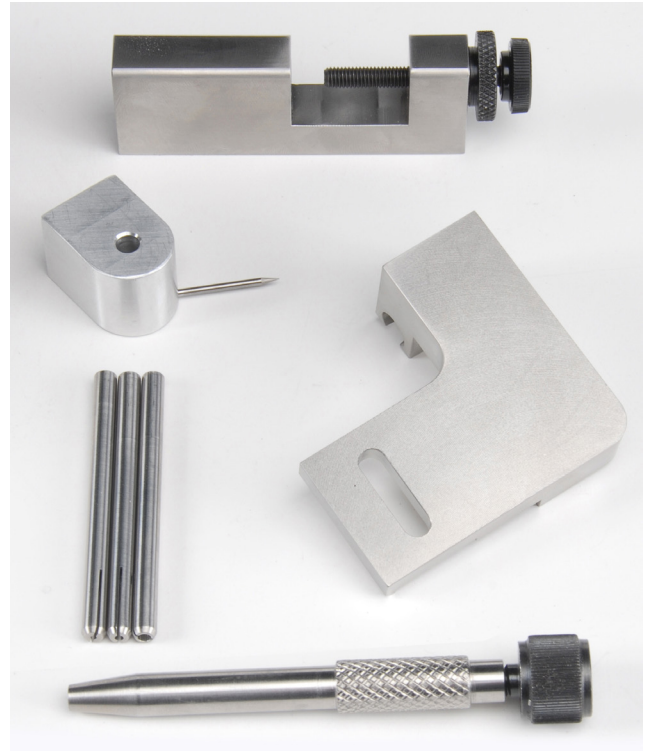

DGP-KIT-PIIs PARTS LIST	
DGP-PG1307	POINTER INDEX/ANGLE
DGP-PG1346	1/16" COLLET
DGP-PG1347	3/32" COLLET
DGP-PG1366	GUIDE BLOCK, COLLET BODY
DGP-PG1367	ADJUSTABLE STOP BLOCK
DGP-PG1368	COLLET BODY WAND
DGP-PG1369	.040" COLLET
DGP-PG1374	BLOCK - ARM PIVOT
DGP-PG1396	THUMB SCREW, BLK ALLOY #1/4-20x3/4"